

Montážny návod nie je považovaný za technickú dokumentáciu.
Výrobca si vyhradzuje právo na konštrukčné zmeny.
V prípade že Vám bude niektorá časť chýbať alebo bude poškodená
označte ju v montážnom návode a pošlite ho dodávateľovi.

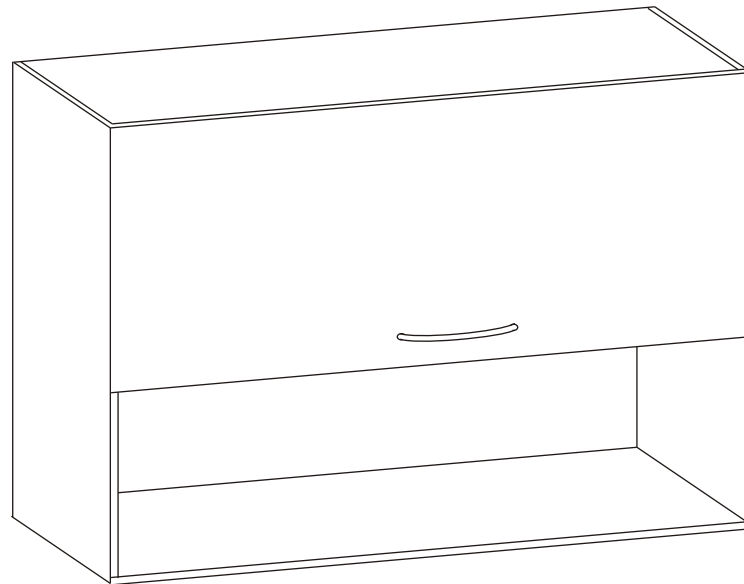

Horná skrinka s poličkou 80 x 57 x 32 cm

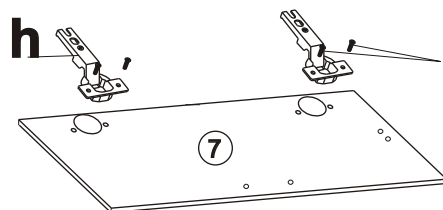

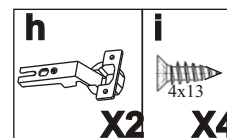
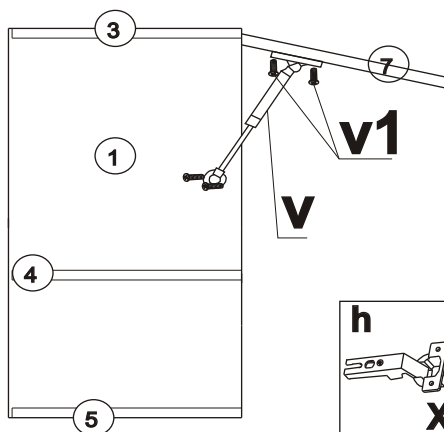
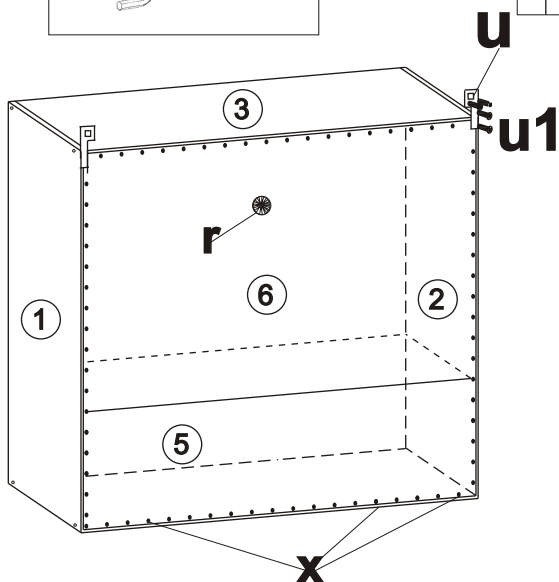
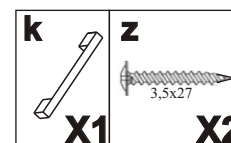
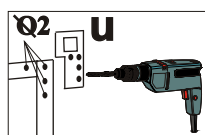
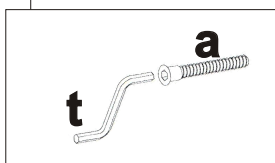
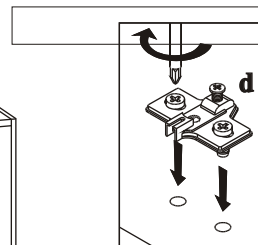
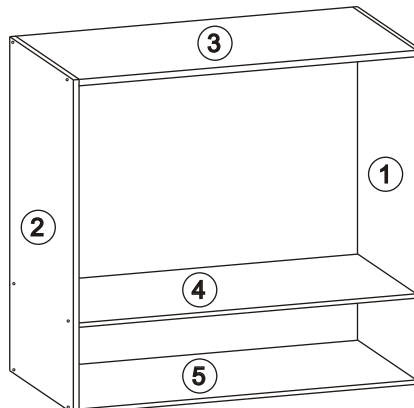
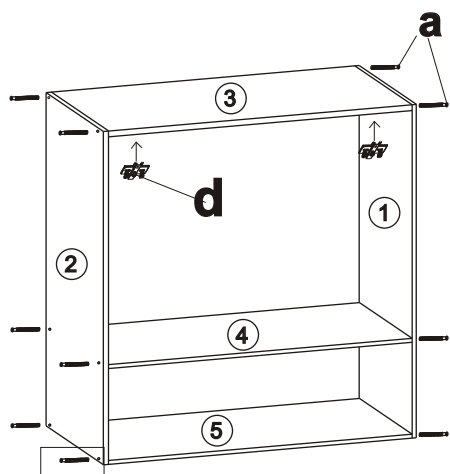

Príslušenstvo

k X1	z X2	x X20	t X1	d X2	h X2	i X4	v X1	a X12	a1 X12	u X2	u1 X8	r X1
--------------------	--------------------	---------------------	--------------------	--------------------	--------------------	--------------------	--------------------	---------------------	----------------------	--------------------	---------------------	--------------------